

KELEN

KE51 KELIT PPR ball valve PN16 50

2662501

Areas of application

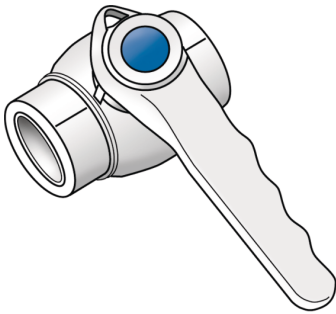

KELIT ball valve polyfusion welding fitting (PP-R), connecting pipes and fittings made of the same material without narrowing the cross section, compatible with KELEN and KETRIX

ATTENTION: Not suitable for minus temperatures

Approvals:



KE KELIT GmbH

A 4020 Linz, Ignaz-Mayer-Straße 17, Austria, Europe

PHONE +43 (0) 50 779 E-MAIL office@kekelit.com

www.kekelit.com

Specifications

Article information

port 1	Plastic welded sleeve
port 2	Plastic welded sleeve
execution	gerade

Product information

VPE1	2,00 SA1
VPE2	8,00 KT1
VPE3	32,00 KT2
weight	0,9230 KGM
text	KELIT PPR ball valve PN16
INTRNR	39174000
main material group	KELEN
material group	KELEN metal fittings
code	KE51

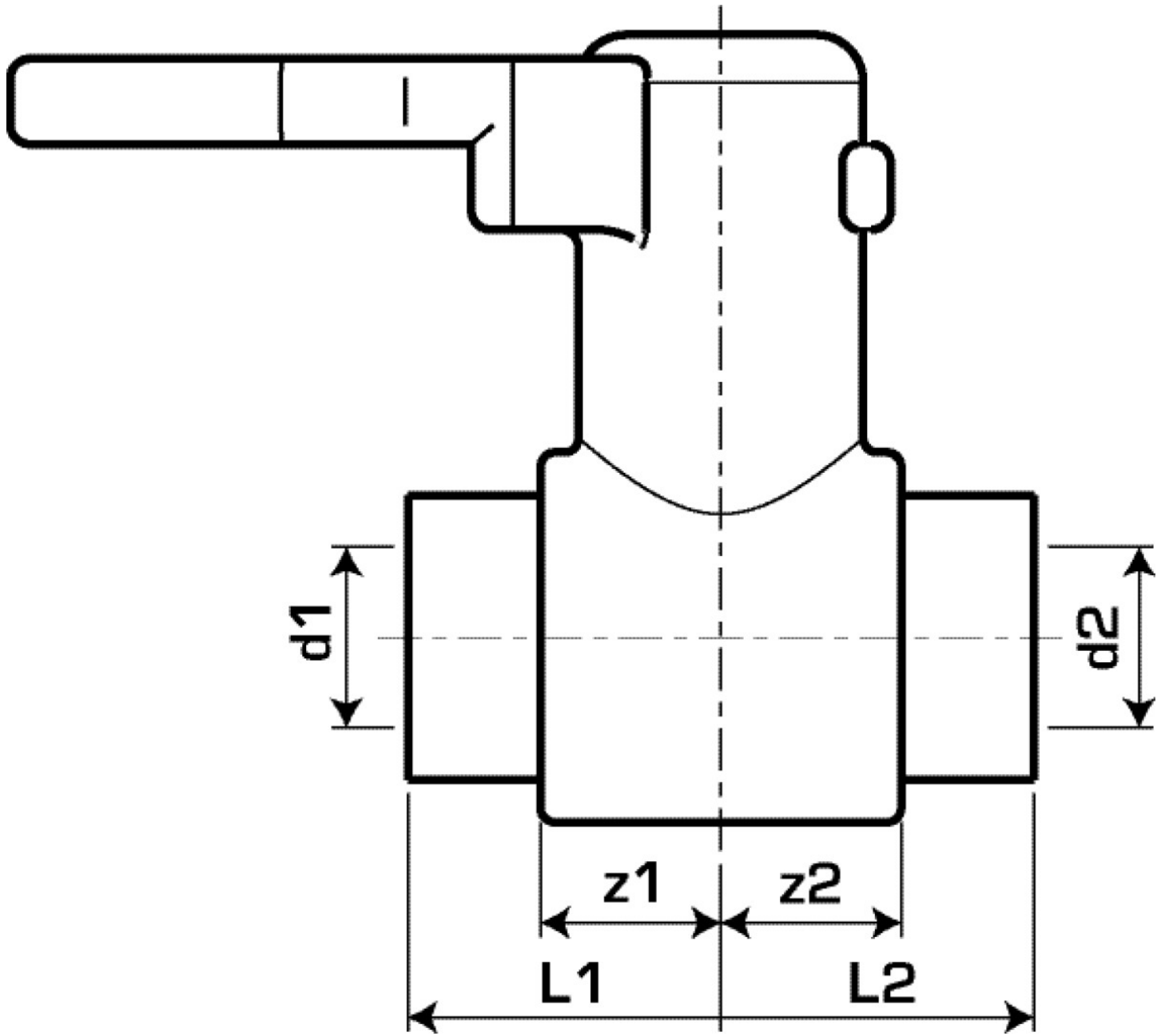

Art. No	label	d1 mm	d2 mm	L1 mm	L2 mm	z1 mm	z2 mm
2662501	50	50	50	58	58	33	33