

# KELIT PEX

## KELIT PEX pre-insulated tee piece SANITARY 40/25/32

3020495045

### Areas of application

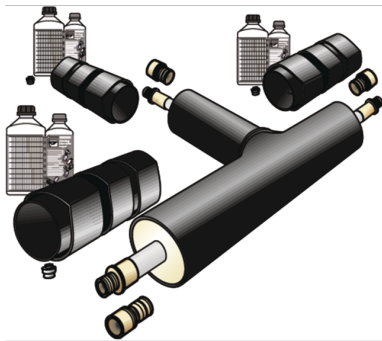

Pre-insulated, polypropylene (PP-R) T-piece straight, equal or reduced INCLUDING 3 medium pipe connections and 3 (PEX40 or PEX45) jacket pipe coupling sleeves

Overall length: 1000 x 500 mm

ATTENTION: THESE ARE NOT EX-STOCK ITEMS!

# Specifications

## Product information

**text** KELIT PEX pre-insulated tee piece SANITARY

## Art. No

3020495045

## label

40/25/32



**KE KELIT GmbH**

A 4020 Linz, Ignaz-Mayer-Straße 17, Austria, Europe

**PHONE** +43 (0) 50 779 **E-MAIL** [office@kekelit.com](mailto:office@kekelit.com)

[www.kekelit.com](http://www.kekelit.com)